

# THERMORY®

When building a sauna, make sure the installation work is performed with quality and precision to make the wood last longer. Wood as a natural material requires regular maintenance to preserve its properties.

Always check the wall panels immediately on receipt to identify any transport damage.

Never install a defective product. When installed, the product is deemed to be of acceptable quality.

Please contact our sales team if you have any questions.

## Installation and Maintenance Guide

1. Storage
2. Preparations for installation
3. Installation of wall panels
  - 3.1 Hidden fixing
  - 3.2 Wall panels fixing
  - 3.3 Installing paneling on ceiling
4. Installation of Tiles by Thermory panels
5. Other tips
  - 5.1 Points requiring special attention
  - 5.2 Treating wooden components
  - 5.3 Tips for using thermally modified wood
6. Sauna maintenance

## Sauna wall panels

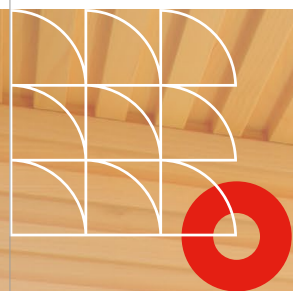

# 1. Storage

Best would be to store your wall panels in the same room where they will be installed for a few weeks before installation to allow the wood to acclimatize to the temperature and humidity conditions in the room.

Store the wall panels on a flat surface, openly stacked and above the floor surface, for example on joists. Make sure that joists would be at least 30 cm

steps to avoid bending. This way enables air movement between the panels.

Wall panels must be stored at the same temperature at which they are going to be installed. The ideal storage temperature is 15–22 °C.

If there is a radiant heater or other heat source in the room used for storing the

wall panels, make sure the humidity level does not rise too high and the temperature does not exceed 25 °C.

Wall panels must be stored in unopened packages. Remove the heat-shrinking film immediately before installation.

# 2. Preparations for installation

Sauna wall panels are installed as part of living area finishing works. When planning the order of construction works, keep in mind the wall paneling does not tolerate changes in humidity during construction.

Make sure sufficient ventilation is provided in the sauna room.

Make sure you have enough material, as there may be slight differences in shade between production batches.

The approximate material loss varies between 5–10% depending on the length for wall panels.

Any wet operations must be performed before installing the wall panels. Performing wet operations after the wall panels have been installed will cause the panels to absorb moisture and swell.

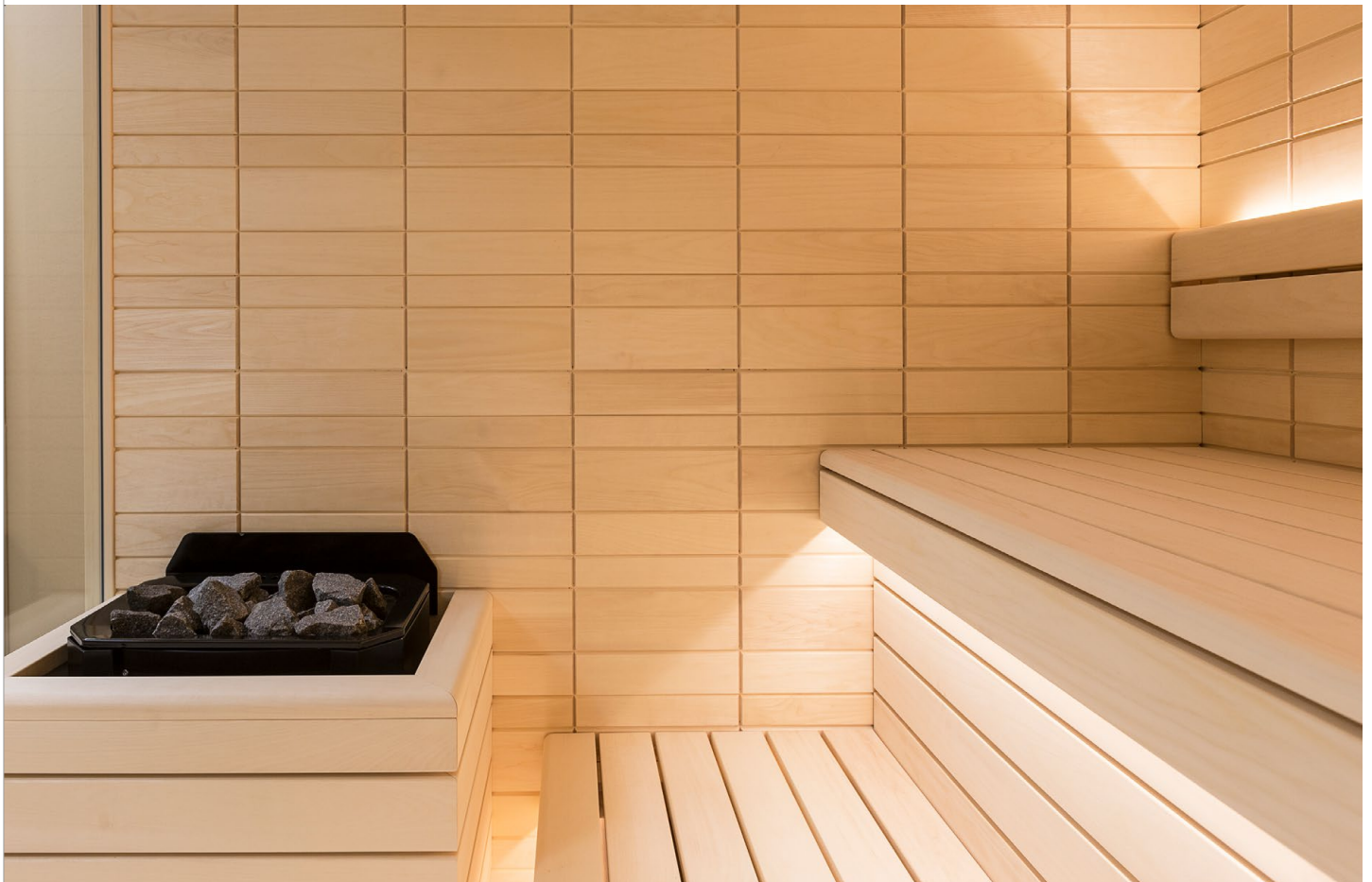



### 3. Installation of wall panels

Installation of horizontal wall panels

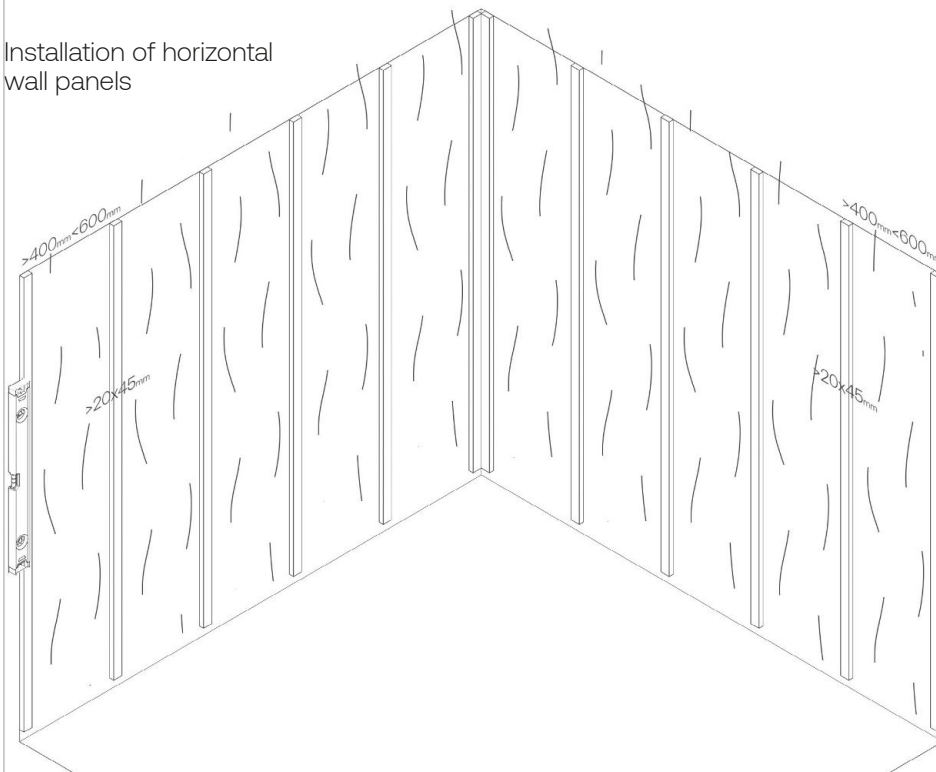

Installation of vertical wall panels

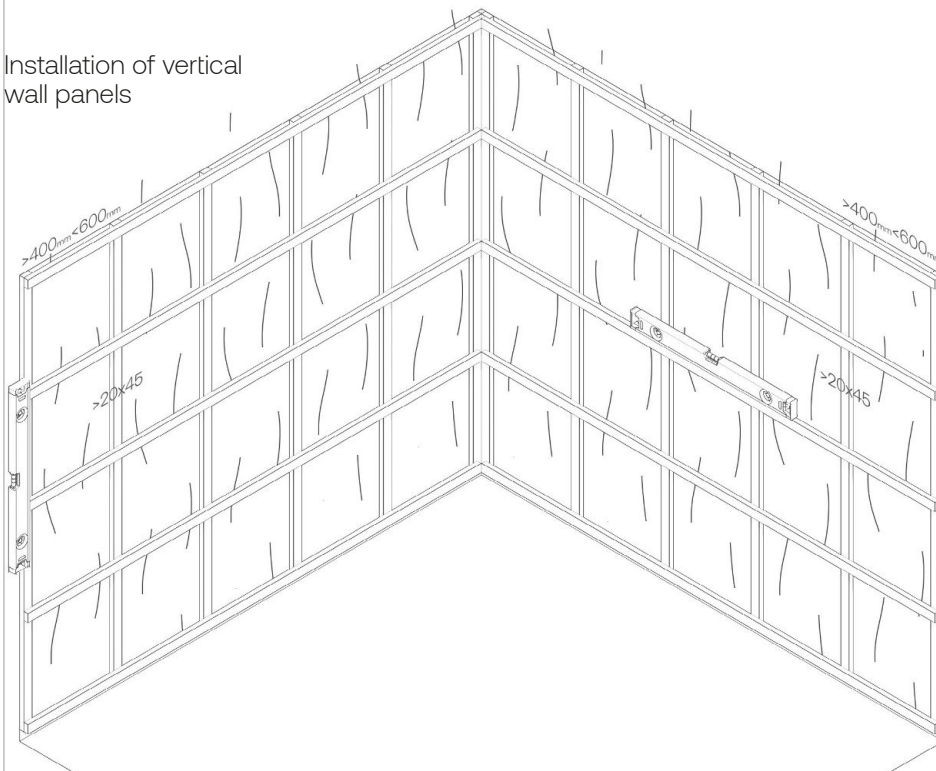

Open several packages so you can better match your wall panels.



We recommend using a staple gun and stainless steel clips for installing the wall panels.



First install the underlay battens to fix the wall panels to. The battens must be at least 20 mm thick and 45 mm wide. We recommend to use Thermory C7 profile for a better air circulation and to make sure that moisture doesn't accumulate behind the lining. If the wall panels are going to be placed horizontally, install the battens vertically. Vertical wall panels, however, require horizontal battens. The battens must ensure air movement behind the wall panels across the entire extent of the paneling



Make sure the battens are straight and level before installing the wall panels. The recommended batten spacing is 400 mm. The batten spacing must not exceed 600 mm.



When installing wall panels horizontally on adjacent walls of a room, start installing the panels row by row on all walls at once, circling the room one row at a time. This way you can align the ends of the panels with precision in the corners.



### 3.1 HIDDEN FIXING

- When installed horizontally, the paneling must be installed from top to bottom.
- Fix with staples from the groove side for both vertical and horizontal installations.
- Position the panels with the tongue side up and groove side down for horizontal installation.
- When installing the wall panels vertically, leave a gap of at least 10 mm between the adjacent corner or board for the first and last panels. Cover the gap with a corner moulding later.
- Check the installation precision of the paneling with a level or measuring tool after every three rows.
- Fix the wall panels to the battens with staples, we recommend the use of a staple gun. Finishing nails are not suitable for fixing the panels. Set the staple penetration depth so the clips would not protrude out of the paneling surface and penetrate too deep and damage the wood surface.
- Make sure the wall panels with hidden fixings are installed down to the bottom.
- Check with a level that the first row of the paneling is installed straight, as installation imprecision will increase for the following rows. Check the installation precision with a level at least after every three rows.

Installation of horizontal wall panels

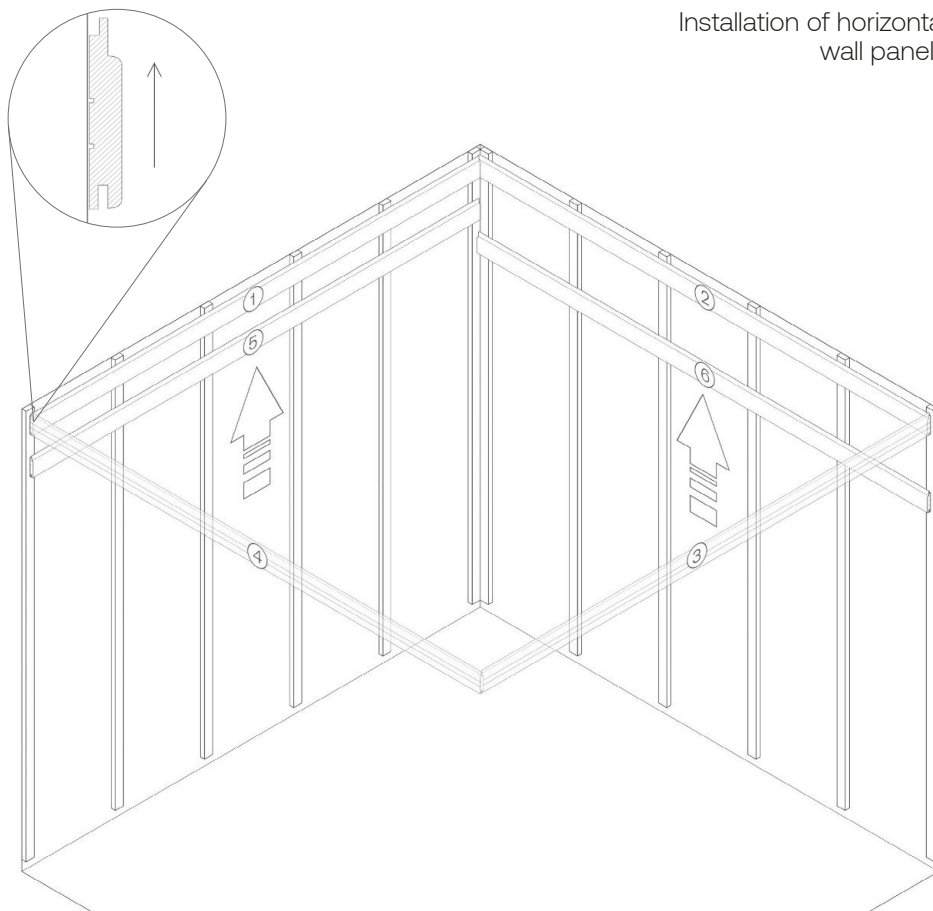

Installation of vertical wall panels

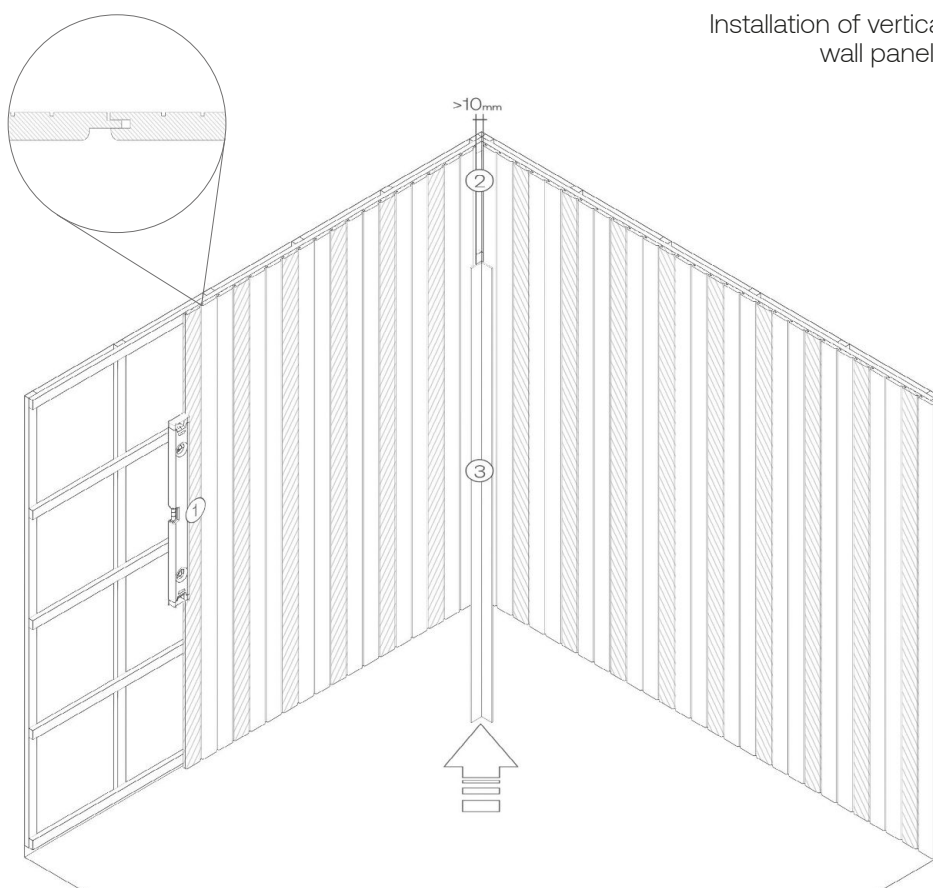

### 3.2 WALL PANELS FIXING

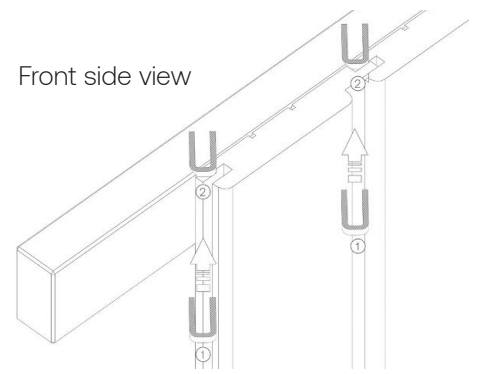
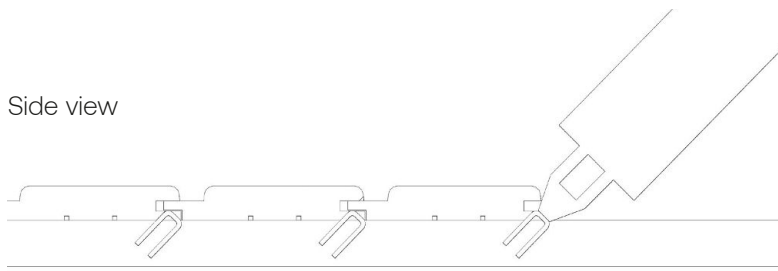

### 3.3 INSTALLING PANELING ON CEILING

If you also want to install the paneling boards on the ceiling, start with the ceiling and cover the walls after that. Installation is similar to installing the horizontal wall paneling. Leave

a sufficient airing gap between the first row of panels and the adjacent wall and between the last row of panels and the wall.

## 4. Installation of Tiles by Thermory panels



Choose the distance between the battens based on the panel length.

The Tiles by Thermory panels are installed with regular joint spacing. To position the joints, first measure the length of the room. Then calculate the size of the panel you should use to start covering the surface so the joints would be evenly spaced.

Continue installing the panels so the joints of all installed panels are positioned in the middle of the panel on the previous row.

Data on Tiles by Thermory boarding

OVERALL LENGTH (MM)
293
578
1148

MAX. LENGTH OF COUNTER BATTERNS (MM)
285
570
600

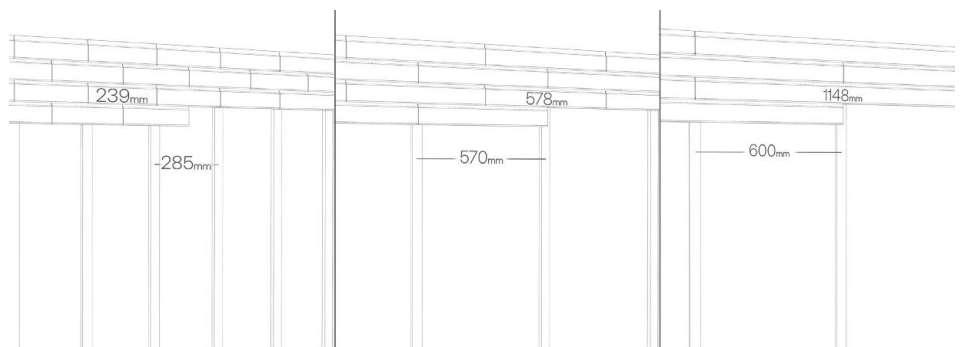

Tiles by Thermory panels horizontal installation

Due to their profile, tiles boarding has many different ways of installation. It is possible to combine boards with different lengths and types of timber. As a result, it is possible to form many unique solutions. In such cases, consult the vendor of the material who is able to give more precise instructions for preparing the surface, about how much material you need, etc.



Tiles by Thermory panels vertical installation

## 5. Other tips

### 5.1 Points requiring special attention

Make sure the panels are installed straight. Perform control measurements from time to time with a direction rope or laser.

Make sure to add support for sauna benches behind the panelling. The weight of the benches must not be carried out by the panels.

Make sure to fasten the panels with the tools for this particular purpose.

If necessary, ask a professional installer for help or hire an installer.

### 5.2 Treating wooden components

To prolong the life of your sauna, we recommend treating all wooden surfaces with a breathable wood protector. The protector will protect against dirt and moisture, facilitate cleaning and enliven the wood surface.

Wipe the wooden parts clean of dust, clean them with a sauna detergent or other detergent suitable for wooden surfaces, and allow to dry. For finishing, the surface must be clean and dry.

Treat the walls and floor grid of your sauna with sauna wax or another suitable coating.

Be sure before finishing, that the paint is suitable for sauna conditions. All finishing has to be done according to paint manufacturer's instructions!

### 5.3 Tips for using thermally modified wood

Thermory's range of sauna products includes a number of wood products having undergone medium and intensive thermal modification. These products require special care in order to preserve the characteristic properties of thermowood.

Handle packages and products with care during installation.

Do not scratch the wooden surface or drag boards on top of each other.

Thermowood has a characteristic scent that will weaken over time but never completely disappear. The scent will disperse faster when letting the sauna heat for a long time and air it at the same time.

You can reduce the characteristic scent of thermowood by treating the wood with a suitable wood wax or maintenance product.

Avoid washing untreated thermowood with water as it will strengthen the scent.

Any complaints about the quality or scent of the wood must be submitted before sawing, installing or treating the wood.

## 6. Sauna maintenance

By following the recommendations below, you will prolong the life of your sauna and keep its fresh look for longer.

### During use

---



Throw water only on the heater, not on the walls or benches. Use seat covers on the bench, they will protect the bench boards and as a bonus also make sitting on the hot wood more comfortable.



Avoid sitting on the sauna bench in wet swimwear.



Check your heating stones, as they may crumble over time.



Replace old stones or add new ones as necessary.



Avoid using cleaning products unsuitable for use in a sauna (for example disinfectants bleaching and damaging the wooden surface).

### After every use

---



Wipe the bench with a clean damp cloth. Do not use running water for cleaning the sauna bench. Make sure excess water does not pool on the wooden surfaces.



Use a suitable cleaning product for cleaning your sauna and other wooden components. Before cleaning, read the in-

structions for use of the product you are going to apply, and make sure it is safe for wooden surfaces.



Allow the surfaces to dry after cleaning the sauna and ensure good ventilation in the room.



Remove the seat covers from the bench boards.

### At least once a year for moderate sauna use, as necessary when using your sauna more intensively

---



Treat the wooden surfaces of the sauna with a product meant for this purpose (see "Installation instructions for sauna wall panels – Treating wooden components"). If the sauna is used often, the surfaces must also be treated more frequently.



Clean all seat, wall and ceiling surfaces with a soft brush or cloth and a special cleaning product, following the instructions provided on the package.



If there are stains or stubborn dirt on the bench, carefully sand the dirty areas with a fine-grained sandpaper, and then treat the sanded areas with a wood preservative (see "Installation instructions for sauna wall panels – Treating wooden components").



Check the fastenings of the bench and supports and tighten the screws, if necessary. These may get loose over time as the changes in heat and humidity make the wood swell and shrink.

### What to avoid?

---



Do not dry your laundry in the sauna because of the risk of fire. Excessive moisture may also damage the wooden surfaces.



Do not exceed the maximum temperature allowed by the manufacturer of the sauna heater when heating the sauna:

excessive heat may pose a fire hazard or cause the wood to warp.



Never use a pressure washer or running water to wash your sauna as excessive moisture could permanently damage the structure and surface of the wood.

### How does wood change in a sauna?

---



Wood is a **natural material** that may crack or warp when exposed to temperature changes. This depends on the wood material used and the intensity of your sauna use.



Wooden surfaces may darken over time (places exposed to hot steam will darken faster).



Thermally modified wood may emit a characteristic scent when the sauna is heated. This will diminish over time.





# Leave a lasting impact

THERMORY is a world leader in the thermal modification of wood. We offer high-quality, long-lasting solutions that benefit from environmentally friendly technology. We have spent the past two decades developing our expertise through close collaboration with architects, designers, builders and homeowners – constantly revising our product selection and refining our technology in the process.

THERMORY promotes a transparent and responsible corporate culture. We care about the environment and treat nature with deep respect. Our purchasing process is environmentally responsible, and we exercise high standards for quality and sustainability. Our timber is carefully inspected and harvested from sustainably managed forests.

- DECKING
- CLADDING
- INTERIOR
- SAUNA

If desired, we can offer PEFC, FSC or Nordic Swan Ecolabel-certified wood.



As a renewable resource that is both durable and an excellent insulator, wood is one of the most environmentally friendly choices for your construction projects. If you think it's important to protect our valuable resources long into the future, then we're on the same mission. We create lasting value, because we want to leave behind a more harmonious and sustainable world.

## REAL WOOD PRODUCTS WITH BEAUTY AND STABILITY IN EVERY FIBER